

Shenzhen EV-PEAK New Energy Technology Co.,Ltd
Tel:+86(755) 88848076 Web:www.ev-peak.com

Thank you for purchasing EV-PEAK Balance Charger. This manual could help you install and operate easily. Please read the manual carefully before operating and keep it handy for further reference. Items herein mentioned is only supplementary to local safety regulations.

WARNING

Very important to understand the items as below. Failure to comply with the mentioned items, it would damage to the charger or battery, injure to your body or even cause a fire disaster.



- Do not put the charger in inappropriate conditions such as direct sunlight, rain, moisture and so on
- Keep it away from thermal source, high voltage, water, flammable gas, corrosives and so on, be sure to keep it at the range of recommended temperature 0°C-40°C/32°F-104°F.
- Keep it horizontally stable to avoid any tilt or shake. And be sure to provide it(around>50cm) with enough ventilation during operating.
- Do not put anything or any cover on the radiator or battery during operating.
- Do not charge any non-rechargeable Lithium batteries with out of specifications.
- Keep the charger and battery on an anti-flammable and anti-conductive surface, and do not put it on car seat, carpet and so on to avoid any losses or damages.
- Do not use any voltage out of the specifications, and provide it with the specified type of battery and number of battery.
- Do not charge or discharge any battery that has been damaged physically.
- Do not plug off the input cable during operating, and plug off timely once charging completed.
- Please wipe off any object attached to the metal ports with dry cloth.
- Do not disassemble or modify the charger by yourself.
- Do not operate it during thunderstorm.
- Keep children under age of 14 away from the charger.
- Do not tumble, short-circuit, reverse polarity to avoid damage before connecting.
- Keep an eye on it during operating.
- Please use dry powder extinguisher in case in fire, and do not take liquid extinguisher to avoid electric shock.

INSTRUCTION

This intelligent charger, with 2 charging channel, charging & maintenance mode, and 3 gear charging speed, automatically detect and run after connected with LiPo battery. The charger also has multi-mechanism protection of over-current, over-charging, over-temperature and safety cut-off, and extra function of fast-equilibrium and status indication.

With the U3 series charger, 2 sets of LiPo battery can be connected simultaneously and charged alternately based on the capacity difference of battery.

With double LCD display equipped, the charger automatically indicates real time charging status, charging voltage, charging current, charging time, battery capacity and cell voltage.

DIAGRAM

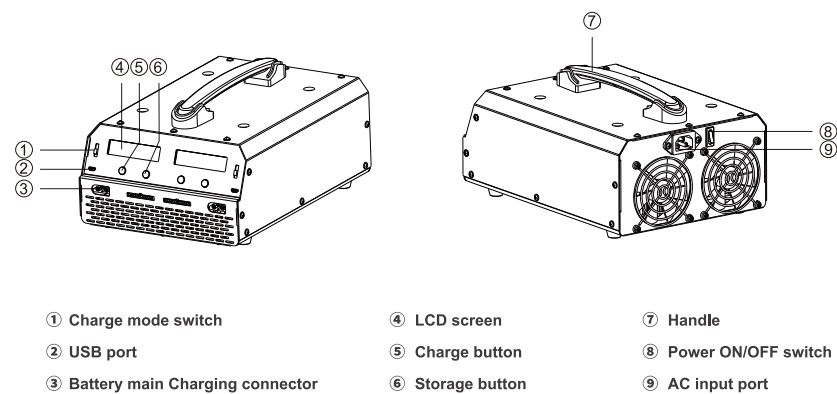

FIRMWARE UPGRADE

Please visit EV-PEAK official website to upgrade firmware if needed and follow the steps as below:

- Visit EV-PEAK official website www.ev-peak.com (<https://www.ev-peak.com/technical-support/>)
- Connect the charger to your computer via Micro USB upgrade port.

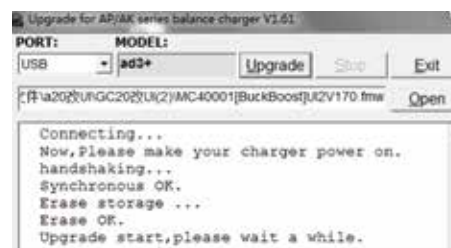
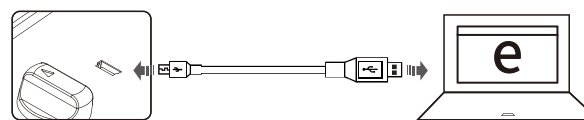

- Run the firmware and click "Upgrade" button to upgrade.
- After upgrade completed, the equipment will restart.
- If failure to upgrade, please restart steps as above.

CONNECTING

- Connect power cord to AC input port and AC power socket (100-240V, 50/60Hz), and turn on "Power On" switch to start up.

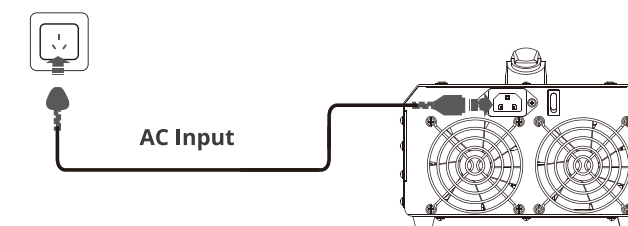

- Connect each LiPo battery pack to the charger via charging and balance port with compatible connectors as illustrated.

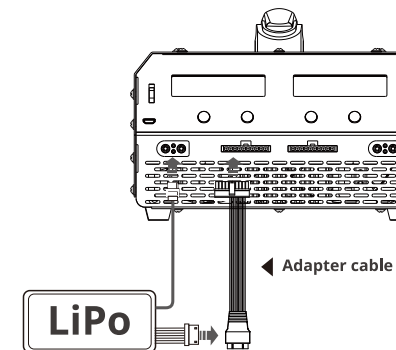

Direct Connecting Diagram



- Before connecting, please check carefully whether terminals and cables are damaged or broken.
- When using the banana head, be sure to connect it with right and correct positive or negative indicator.

OPERATING

The charger is dual channel with independent output and independent interface. Take either channel of the charger for example as below:

1. Startup and Self-Test

The charger automatically count down after getting all the connectors well connected, LCD screen turning on, and buzzer alarming. The charger starts charging normally after the buzzer stops. Long press "Storage" button for more than 2s to function storage.

2. Operation Modes

- Charging mode:** It's an automatically preferred mode, after getting the battery well connected, the charger countdown self-checks, automatically detects and starts up charging, or bypassing countdown self-check and directly manual startup.
- Storage mode:** It's a manual mode, while battery is in idle, recommended to take storage every 15 days; or while battery life significantly declines or more than 50mV cell voltage tolerance; In storage mode, the charger charges and discharges with trickle current to get each cell voltage balanced to 3.84-3.86v.
- Continuous working mode:** After getting the charging extension manager connected, the charger automatically detects and switches to continuous working mode. In this mode, automatic mode doesn't work any more, user needs to manually operate and define the continuous working mode once, and then the charger coordinately and continuously work with the charging extension manager until pressing any button to stop or power off.

3. Setting Of Charging Modes

Based on battery capacity and actual application, adjust current switch to right gear.

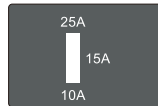

4. Charging

- Red LED always on: charging, screen shows realtime status during charging.
 - Green LED always on: charge finished.
 - Press any button to stop charging.
- Attention: In continuous working mode, the charger will automatically perform a series of actions such as stopping, detecting, switching channels, etc. These actions are intelligently executed by the charger without any manual operation.

5. Storage

- Red LED always on: storing, screen shows realtime status during storing.
 - Green LED always on: storage finished.
 - Press any button to stop storing.
- Attention: In continuous working mode, the charger will automatically perform a series of actions such as stopping, detecting, switching channels, etc. These actions are intelligently executed by the charger without any manual operation.

SCREEN

The interface displayed as below:

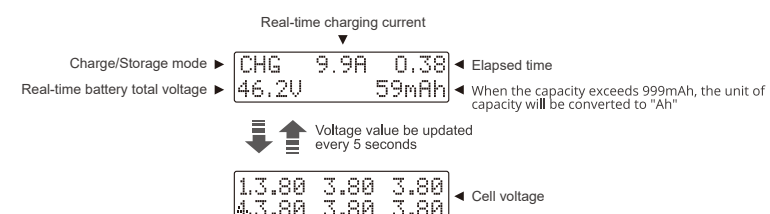

ERROR!

When the wrong use of charger or failure, the charger will prompt an error message! As shown below:

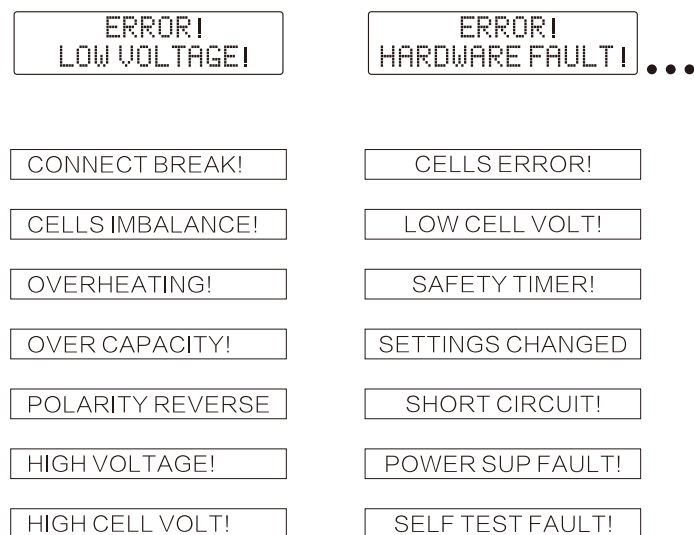

LED INDICATION DESCRIPTION

LED Indication	Description
Green flash	Standby
Red on	Working
Green on	Finish
Green and Red flash alternately	Error

SPECIFICATIONS

AC Input	100V-240V-12.0A 50/60Hz
Output	10A/15A/25A
Max. Output Power	600W X2
Battery Cell Count	6S
Battery Type	LiPo/LiHV/Smart battery
Channel Count	Dual channel
Input Protection	Overcurrent
Output Protection	Overvoltage, Undervoltage, Short circuit, Over temperature, Reverse polarity
Working Temperature	5-45 C
Cooling System	Forced air cooling
Upgrade Port	USB
Dimensions	286.9X200X146mm
Weight	2.89KG

Note: The product specifications mentioned in this manual are for reference only and are subject to change without prior notice.

SUPPORT AND WARRANTY

Thank you for purchasing EV-PEAK charger. We do our best to provide you with timely support. Do not hesitate to contact us whenever you have issue with EV-PEAK charger.

- The deadline of warranty is subject to the date on which EV-PEAK receive the item.
- We provide you with one year warranty from purchase date for manufacturing defects; in some case, the purchase date can't be provided, it is subject to the recording date from EV-PEAK.
- Beyond one year from purchase date, it depends it charge a portion of fees, besides the shippings back and forth.
- Please provide your contact information in detail to contact you timely after warranty.

Disclaimer:

- Damage caused by wrong connecting out of specifications.
- Damage caused by wrong operations against instructions.
- Damage caused by intended or accidental bump and force majeure.
- Damage caused by disassemble and modify by yourself.
- Internal damage caused by moisture, soaking, dust and so on.
- External body aging, scratches and so on.



Attention: Any expense exceeding product cost shall not be borne by EV-PEAK, and EV-PEAK reserves any right to modify and explain these clauses.

WARNING!

- This charger is not designed to use for people who has physical, sensory or mental disabilities or lack of related experience and knowledge.
- Please take care of children and be sure to keep children away from it while charging.
- Please turn off the power to avoid any possibility of electric shock if the surface is broken.
- The charger is for indoor use only.



EV-PEAK®
Shenzhen EV-PEAK New Energy Technology Co.,Ltd
www.ev-peak.com

The product specifications and information mentioned in this instruction manual are for reference only and are subject to change without prior notice.

Copyright © Shenzhen EV-PEAK New Energy Technology Co.,Ltd