

UD2-100

Instruction Manual

Support LiPo/LiHV/Smart battery

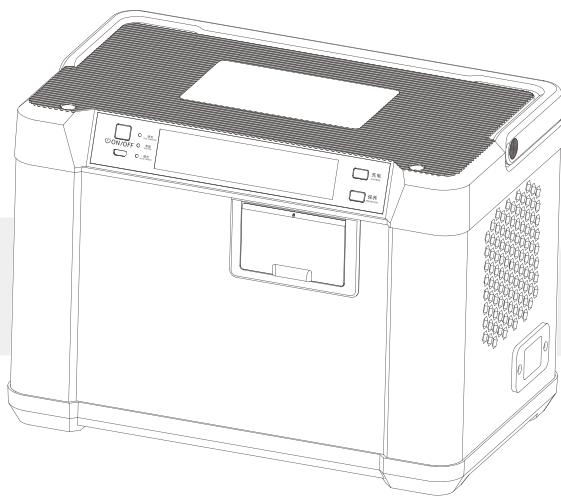

Shenzhen EV-PEAK New Energy Technology Co.,Ltd.

Phone:+86(755)88848076

Email:www.ev-peak.com

Preface

Thank you for choosing EV-PEAK smart fast charger; this operating instruction is designed to help you better install and use this product, so please read this instruction carefully before using it, and keep it in a safe place. The safety items mentioned in this manual are only a supplement to local safety regulations.

Safety Guidelines

These warning safety tips are very important, improper operation may cause the charging damage to the device or other equipment, or even cause electric shock or fire.



WARNING

1. Do not use this product in direct sunlight, rain or humid environment.
2. This product should be kept away from heat sources, high voltage electricity, water, flammable gases, corrosives and other dangerous items; it must be used at a suitable ambient temperature (5°C~45°C is recommended).
3. The product should be placed on a horizontal platform, and it is forbidden to tilt or vibrate; there must be enough ventilation distance around (recommended >50cm) to ensure good ventilation when the product is working.
4. It is forbidden to cover the radiator or battery of the product with objects during operation; it is also forbidden to place the battery on the radiator.
5. It is forbidden to charge non-rechargeable lithium batteries that do not match the number of cells or specifications.
6. During operation, the device and battery should be placed on a surface with strong resistance to flammability and resistance to conductors. It is forbidden to place it on car cushions, carpets or similar objects, and ensure that all flammable and explosive products are kept away from the operating area.
7. It is forbidden to try to use voltage exceeding the operating voltage specified in the manual; the number of cells and type of batteries must comply with the settings.
8. It is forbidden to charge and discharge a battery that has been physically damaged.
9. It is forbidden to pull out the input line during the working process. After the work is completed, please pull out the battery in time.
10. If there are foreign objects attached to the metal terminals, please wipe them with a dry towel.
11. It is forbidden to modify or disassemble this product by yourself.
12. It is forbidden to use this product in thunderstorm weather.
13. Children under the age of 14 (inclusive) are prohibited from using the charger to avoid accidents.
14. Before connecting the battery, it is forbidden to beat the battery, short-circuit the positive and negative poles of the battery, and disassemble the battery by yourself to avoid danger.
15. In the process of using this product, make sure someone is guarding it.
16. In case of fire, please use a dry powder fire extinguisher correctly to extinguish the fire. Using a liquid fire extinguisher may cause electric shock.

Warning

- This product is not suitable for people (including children) with physical, sensory or mental disabilities or lack of experience and knowledge.
- This product is not a toy, please take good care of children and make sure they cannot play with these products.
- If there is a crack on the surface, turn off the power to avoid the possibility of electric shock.
- This product is for indoor use only!



Part Name

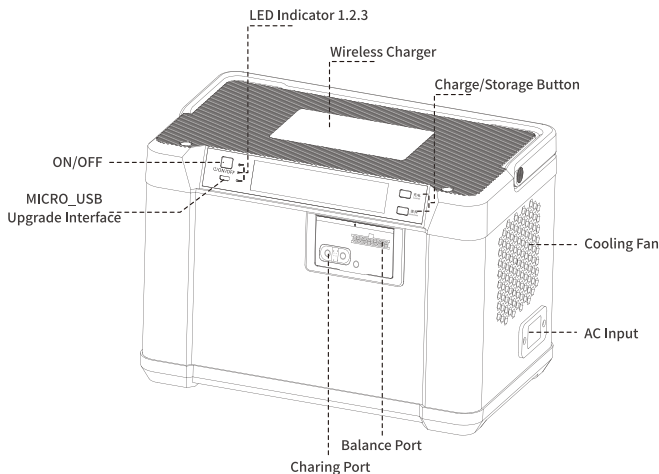

Indicator light description

Fast charge mode	①	White light is always on
Medium charge mode	②	Red light is always on
Slow charge mode	③	Yellow light is always on

Product specification

AC input Voltage	AC 100-240V
DC output	Max.108.0V = Max.35A
Output Power	AC 100-180V maximum output power is 1500W AC 180-240V maximum output power is 3000W
Battery Type	LiPo/LiHV/Smart battery
Battery cells	20S-24S
Channels	2CH
Balance accuracy	±20mV
Protection feature	Overvoltage, voltage limiting, current limiting, overheating, short circuit, reverse connection
Working temperature	5-45°C
Cooling system	Forced air cooling
External upgrade interface	USB interface
Dimension	300x180x215mm
Weight	≈7.1kg

Note: The product specifications mentioned in this practical manual are for reference only, and will not be notified if there is any content update.

Screen display instructions

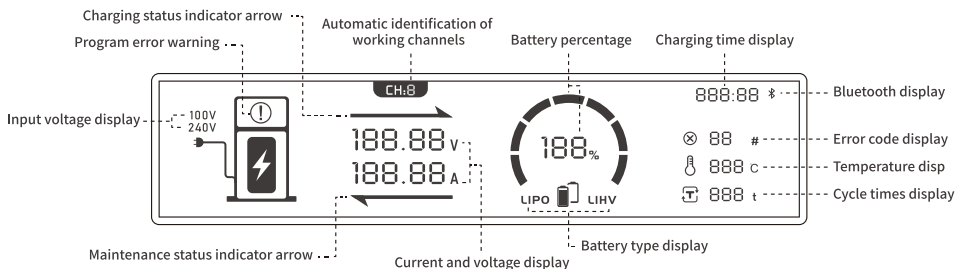

1. In the error state - no current display.
2. The charging/maintenance status arrow is only displayed in the corresponding status.
3. Short press Charge button to stop charging, short press Storage button to switch the channel.

Error code comment

1	Current zero drift is too large	36	Battery overheating
2	Poor contact	37	The charger failed to start
3	The error between the balance port and the total voltage exceeds 2.0V	38	The charger failed to start
4	There is a battery before starting, after 2 seconds the battery is removed	39	DJI485 communication lost
5	Terminal balance port unconnected	40	Battery low temperature
6	The number of batteries does not match	50	The mode cannot be changed during charging and discharging!
7	No battery	60	Unsupported power supply model
20	Total battery voltage is too high	61	Power failure, communication timeout
21	The total battery voltage exceeds the maximum set voltage by 1v	62	Power failure, short circuit failure, stop charging
22	Total voltage low	63	Power failure, overheat protection, stop charging
23	Single cell voltage is too high	64	Power failure, AC input undervoltage detected
24	Single cell low voltage	65	Power failure, AC input failure detected
25	Charger resistor overheated	66	Power failure, the power may have shut down unexpectedly
26	Discharge short circuit or overload	67	Power failure, fan failure detected
27	Safety timer arrives	68	Unsupported power supply model
28	The capacity exceeds the safety threshold	210	Wrong hardware version
29	BMS communication error	211	Wrong battery type
31	CAN communication timeout	212	Wrong cell number of batteries
32	The BMS connection is interrupted, and the CAN contact is poor, resulting in communication interruption	213	Battery single cell voltage error
33	Equalizer failure	214	Not calibrated
34	Discharger failure	215	Calibrate voltage before calibrating current
35	Upgrade failed		

Operation introduction

Note: DO NOT charge the battery if battery temperature higher than 45°C.
Charger will warning when smart battery temperature higher than 45°C.

Hold the "ON/OFF" button to turn on/off the charger.
then short press it to choose the charge mode.
There're 3 modes: fast charge, normal charge and
slow charge.

The current mode can be viewed through the
LED indicator

Please refer to page 2 for LED indicator notes

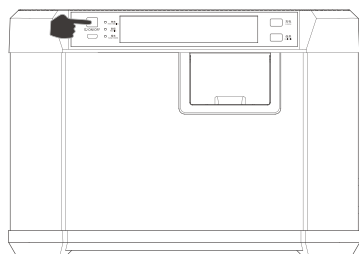

Long press the "charge button" to enter the
charging mode

Short press to switch charging channels

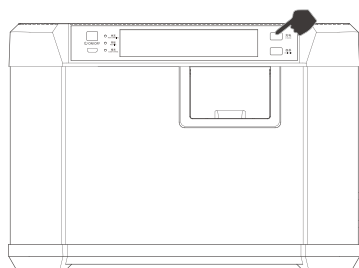

Long press the "maintenance button" to enter the
maintenance mode

Short press to switch charging channels

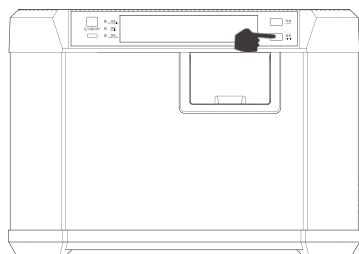

Link description

1. UD2-100 battery connection schematic diagram, the battery can be connected to the charger, if the battery socket does not match, the battery can be connected through the transfer line.

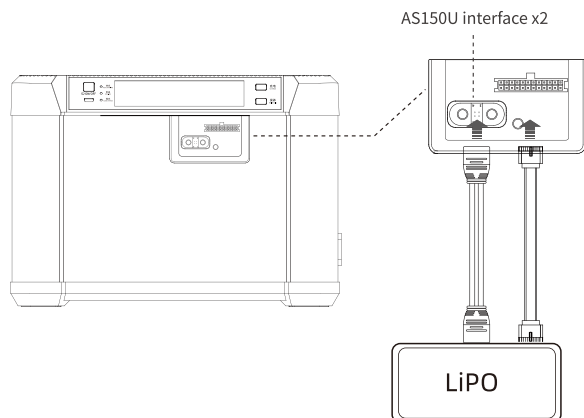

2. First connect the power cord to the AC input port, and the other end to the AC power supply (100-240V, 50/60Hz), turn on the power switch, and start the charger.

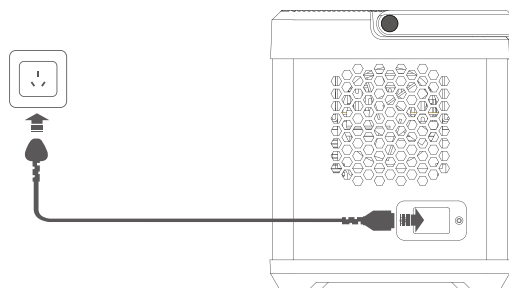

Description of different charging gears

		Charge mode	Charge method	Charge current EACH CH
2 batteries connected	initial voltage same	fast mode	one by one	max. 35A
		standard mode	simultaneously	max. 25A
		slow mode	simultaneously	max. 15A
	initial voltage different	fast mode	one by one	max. 35A
		standard mode	Charge the lower battery first, then simultaneously charge once the initial voltage became same	max. 25A
		slow mode	Charge the lower battery first, then simultaneously charge once the initial voltage became same	max. 15A
1 batteries connected	/	fast mode	/	max. 35A
		standard mode	/	max. 25A
		slow mode	/	max. 15A

Firmware upgrade

If the firmware of the charger needs to be updated, please pay attention to the firmware upgrade program that will be released on the EV-PEAK official website, and perform the firmware upgrade according to the following steps:

1. Visit EV-PEAK official website to download the latest firmware upgrade program (<http://www.ev-peak.com/firmware>)
2. Make sure AC power cord unconnected, connect the charger, and use the USB cable to connect the firmware upgrade interface to the computer.

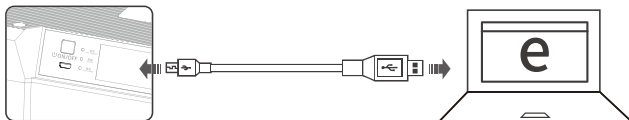

3. Run the firmware upgrade program, load the firmware file with the suffix fmw, click the upgrade button, then connect the power cord, and wait for the upgrade.



4. After the upgrade is successful, the device will automatically restart.
5. If the upgrade fails, please try to upgrade again.

For detailed steps, please follow the prompts to upgrade the software!

Package contains

This product includes: UD2-100 smart balance charger x1 AC power cord x1 remote control software download link x1 after-sales service card x1



UD2-100
Smart Balance Charger



AC power cord



Remote control software

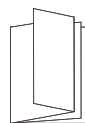

After-sales service card

After sales and warranty

Thank you for purchasing the charger from our company. EV-PEAK will do its best to provide you with perfect after-sales service and fully protect your rights and interests. If your product fails, please contact the after-sales personnel of EV-PEAK.

1. The warranty deadline after the product fails is subject to the after-sales service center of EV-PEAK;
2. Due to the quality problem of the product itself within one year from the date of purchase, all warranties are free. If the customer cannot provide a valid purchase certificate, the internal date code shall prevail;
3. If the period exceeds one year from the date of purchase, the cost will be charged as appropriate, and the user must bear the round-trip transportation costs;
4. When you send for repair, please be sure to leave your contact information, so that you can be notified in time after repair.

The product is damaged and cannot be used normally due to the following reasons, which is not covered by the warranty:

1. Failure to connect to the correct voltage as required leads to damage to the product;
2. Damage caused by improper use in accordance with the instructions;
3. All man-made, accidental impact or other force majeure causes damage to the product;
4. Unauthorized modification, disassembly or modification of the internal circuit of this product without the approval of the company;
5. Damage caused by water immersion, moisture or other foreign matter entering the product;
6. Aging, bumps and scratches on the surface of the product.



Please pay attention to correct use: the user is responsible for any consequences caused by the operation, and the company is not responsible for the expenses beyond the product cost and reserves the right to modify this clause; if there is any modification, no prior notice will be given.

EV-PEAK

Shenzhen EV-PEAK New Energy Technology Co.,Ltd
www.ev-peak.com

The product specifications and information mentioned in this instruction manual are for reference only, and are subject to update



Copyright Shenzhen EV-PEAK New Energy Technology Co., Ltd. All rights reserved